



TYPHOON INTAKE SYSTEMS

INTAKE SYSTEMS FOR VEHICLES LISTED ARE 50 STATE LEGAL. SEE KNFILTERS.COM FOR CARB STATUS ON EACH PART FOR A SPECIFIC VEHICLE.

INSTALLATION INSTRUCTIONS

69-7001TTK

NISSAN

2007-12 Sentra SE-R / SE-R Spec-V

L4-2.5L

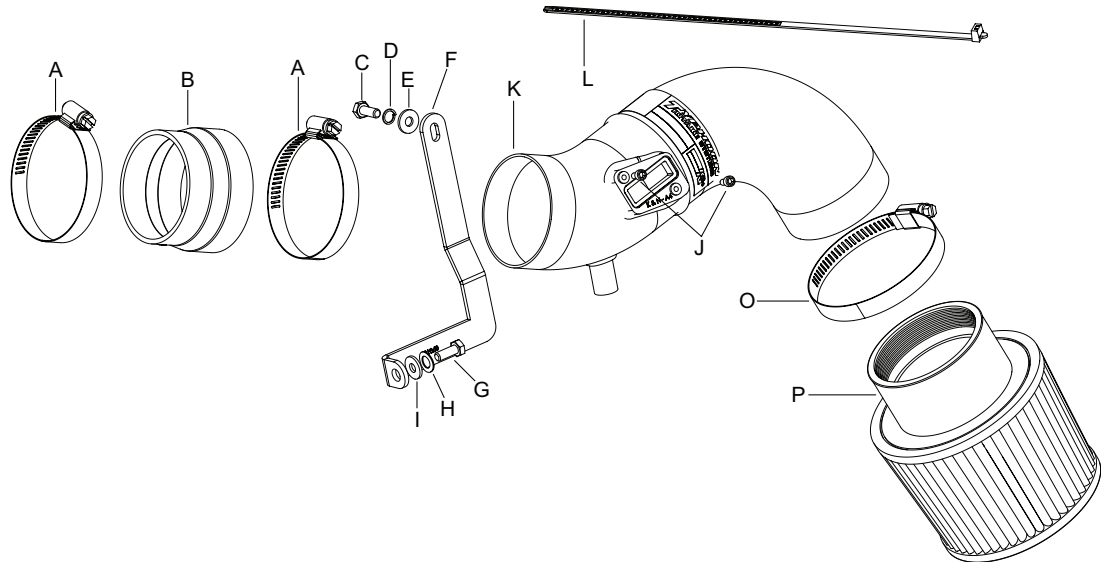

TOOLS NEEDED:

- 10mm Socket
- 13mm Socket
- Extension
- Flat Blade Screwdriver
- Pliers
- Ratchet

PARTS LIST:

Description	Qty.	Part #
A Hose Clamp #44	2	08560
B Hose; 2-3/4" to 3" x 2" L,	1	084036
C Bolt; 6MM-1.00 X 16mm, SS	3	07812
D Washer; 1/4" Lock, ZN	3	08198
E Washer; 1/4"ID X 5/8"OD - SAE	3	08275
F Bracket; "L", STL, FB/PC	1	070103
G Bolt; 8MM-1.25 X 16mm, Hexhead	1	07844
H Washer; 8mm Spring Wave	1	08239
I Washer; 5/16"ID X 5/8"OD, Flat	1	08276
J Bolt; M4 - 0.07 8mm, A/H Cap, SS	2	07733
K Intake Tube	1	27551
L Cable Ties; 11" Black	1	21590
M Edge Trim (39")	1	102496
N Heat Shield	1	074043-1
O Hose Clamp #48	1	08601
P Air Filter	1	RU-3700

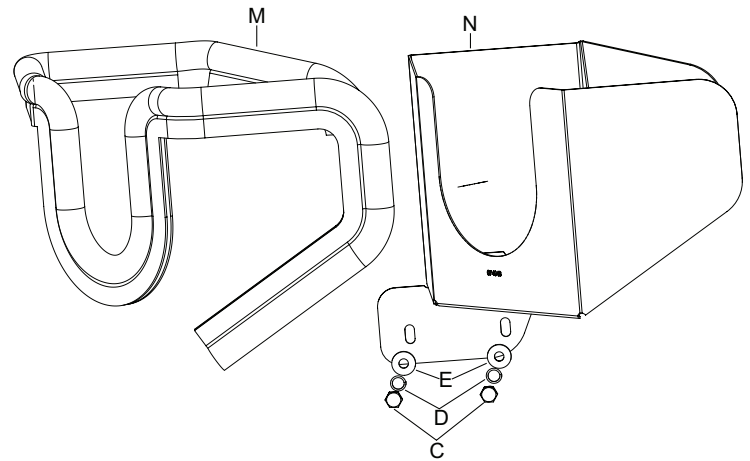

NOTE: FAILURE TO FOLLOW INSTALLATION INSTRUCTIONS AND NOT USING THE PROVIDED HARDWARE MAY DAMAGE THE INTAKE TUBE, THROTTLE BODY AND ENGINE.

TO START:

1. Turn off the ignition and disconnect the negative battery cable.

NOTE: Disconnecting the negative battery cable erases pre-programmed electronic memories. Write down all memory settings before disconnecting the negative battery cable. Some radios will require an anti-theft code to be entered after the battery is reconnected. The anti-theft code is typically supplied with your owner's manual. In the event your vehicles' anti-theft code cannot be recovered, contact an authorized dealership to obtain your vehicles anti-theft code.

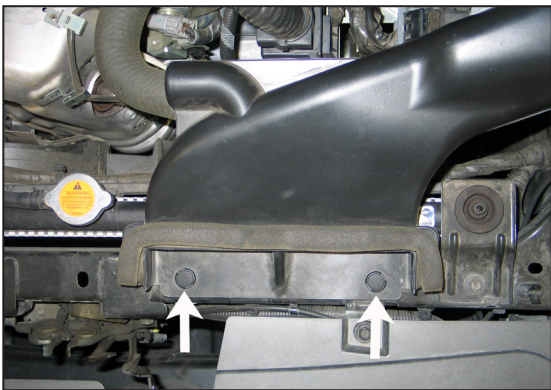

2. Remove the two retaining clips which secure the fresh air supply duct to the core support.



3. Remove the fresh air supply duct from the vehicle.



4. Disconnect the positive battery cable, then loosen the bolt and remove the battery hold down bracket.



5. Remove the battery from the vehicle.

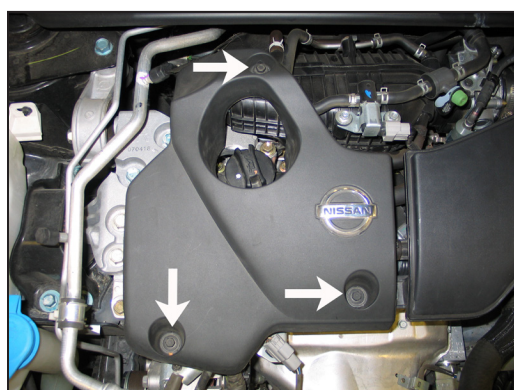

6. Remove the three bolts which secure the engine cover and then remove the engine cover.



7. Release the spring clamp which secures the crankcase vent hose to the intake plenum and then disconnect the crankcase vent hose.



8. Remove the resonator mounting bolt and loosen the hose clamp which secures the resonator to the intake tube. Remove the intake resonator from the vehicle.

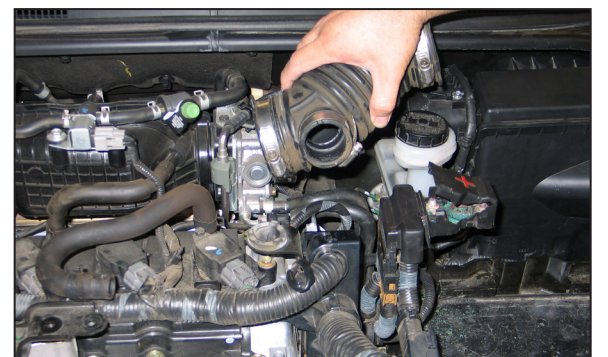

9. Loosen the hose clamps which secure the intake tube and then remove the intake tube from the vehicle.

NOTE: K&N Engineering, Inc., recommends that customers do not discard factory air intake.



10. Disconnect the mass air sensor electrical connection and then release the harness from the airbox.

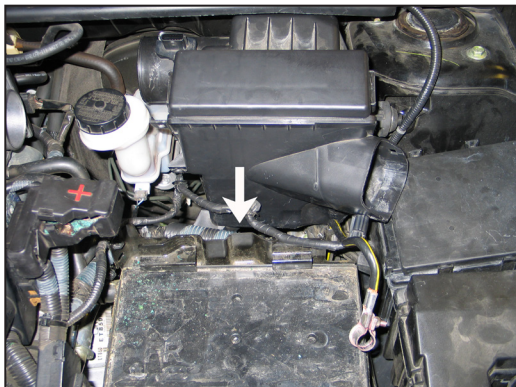

11. Remove the airbox mounting bolt located below the wiring harness, between the battery tray and airbox.

NOTE: On some automatic transmission equipped vehicles, the TCM module is attached to the battery tray. It will be necessary to remove the battery tray mounting bolts so the TCM can be moved to allow the airbox to be removed.

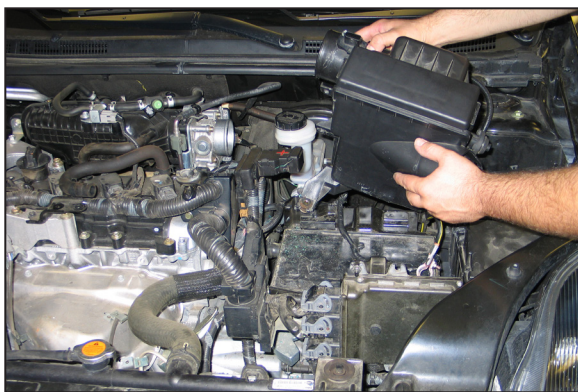

12. Remove the airbox from the vehicle.

NOTE: Be patient while removing the airbox, it is a tight fit and requires some maneuvering to get out. Loosening the battery tray bolts will ease removal but is not absolutely necessary. On automatic equipped vehicles, be sure to reattach the battery tray and TCM module. NOTE: K&N Engineering, Inc., recommends that customers do not discard factory air intake.

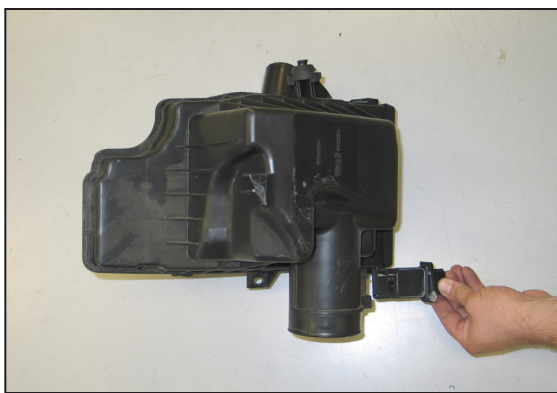

13. Remove the mass air sensor from the factory airbox.



14. Install the mass air sensor into the K&N intake tube and secure with the provided hardware.



15. Install the provided edge trim onto the heat shield.

NOTE: The edge trim will need to be trimmed for proper fit.



16. Secure the heat shield to the inner fender using the provided hardware.

NOTE: The provided fasteners will thread into two existing threaded holes in the inner fender.

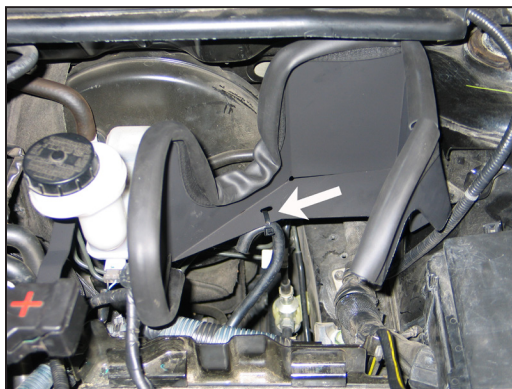

17. Secure the transmission vent hose to the heat shield with the provided tie wrap passing through the hole in the bottom of the heat shield.

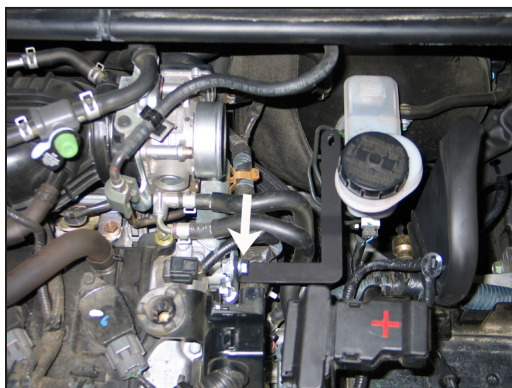

18. Install the intake tube mounting bracket onto the engine lifting bracket and secure with the provided hardware.

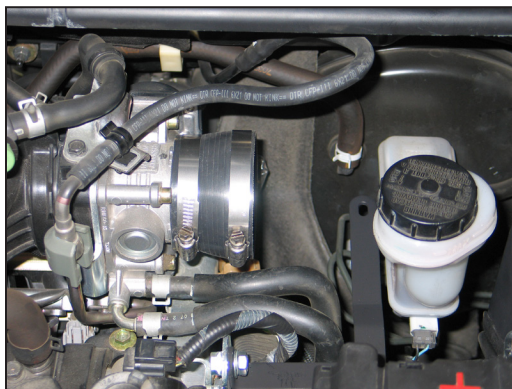

19. Install the silicone hose (084036) onto the throttle body and secure with the provided hose clamp.

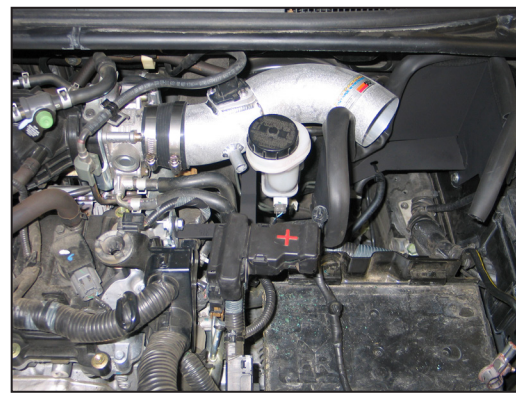

20. Install the K&N intake tube into the silicone hose on the throttle body and align with the mounting bracket installed in step #19. Secure with the provided hardware and hose clamp.



21. Install the crankcase vent hose onto the K&N intake tube and secure with the factory hose clamp.

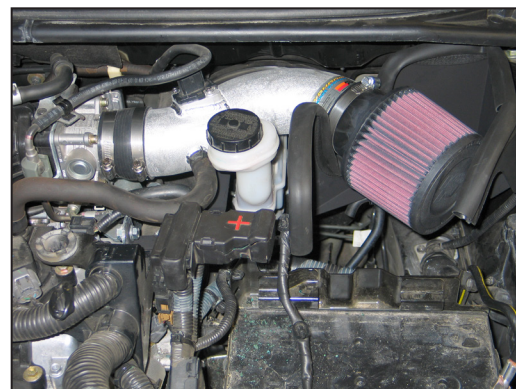

22. Install the K&N air filter onto the K&N intake tube and secure with the provided hose clamp.



23. Reinstall and secure the battery, reconnect the positive battery cable.



24. Reinstall the fresh air supply duct and secure with the factory plastic retaining clips.
NOTE: Be sure the duct is secured under the heat shield.

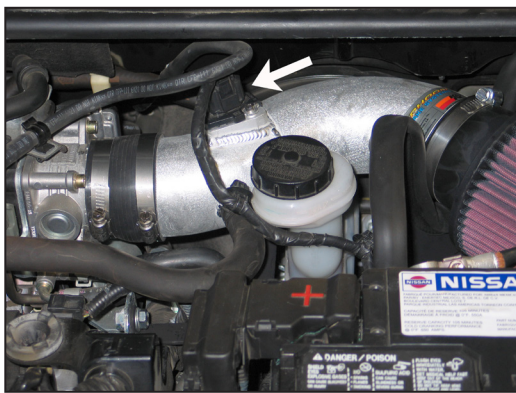

25. Reconnect the mass air sensor electrical connection.



26. Reinstall the intake resonator and secure with the factory bolt.



27. Reinstall the engine cover and secure with the factory bolts.



28. Reconnect the vehicle's negative battery cable. Double check to make sure everything is tight and properly positioned before starting the vehicle.

29. The C.A.R.B. exemption sticker, (attached), must be visible under the hood so that an emissions inspector can see it when the vehicle is required to be tested for emissions. California requires testing every two years, other states may vary.

30. It will be necessary for all K&N® high flow intake systems to be checked periodically for realignment, clearance and tightening of all connections. Failure to follow the above instructions or proper maintenance may void warranty.

ROAD TESTING:

1. Start the engine with the transmission in neutral or park, and the parking brake engaged. Listen for air leaks or odd noises. For air leaks secure hoses and connections. For odd noises, find cause and repair before proceeding. This kit will function identically to the factory system except for being louder and much more responsive.
2. Test drive the vehicle. Listen for odd noises or rattles and fix as necessary.
3. If road test is fine, you can now enjoy the added power and performance from your kit.
4. K&N Engineering, Inc., suggests checking the air filter element periodically for excessive dirt build-up. When the element becomes covered in dirt (or once a year), service it according to the instructions on the Recharger® service kit, part number 99-5050 or 99-5000.

INTAKE SYSTEMS FOR VEHICLES LISTED ARE 50 STATE LEGAL. SEE KNFILTERS.COM FOR CARB STATUS ON EACH PART FOR A SPECIFIC VEHICLE.